

[54] **GOGGLES**

5,867,841 2/1999 Chiang 2/436

[75] Inventor: **Maurice Bolle**, Oyonnax, France

OTHER PUBLICATIONS

[73] Assignee: **Bolle Inc.**, Wheat Ridge, Colo.

Eight Bollé Catalogs for 1991, 1992, 1993, 1994, 1995, 1996, 1997, 1998.
Sunglass Hut, P29, 1994.

[**] Term: **14 Years**

Primary Examiner—Raphael Barkai
Attorney, Agent, or Firm—Merchant & Gould P.C.; John B. Phillips; Gregg I. Anderson

[21] Appl. No.: **29/113,864**

[22] Filed: **Nov. 12, 1999**

[57] **CLAIM**

[51] **LOC (7) Cl.** **16-06**

[52] **U.S. Cl.** **D16/312**

[58] **Field of Search** D16/101, 300-330;
D29/109, 110; D24/110.2; 351/41, 44; 2/424,
426, 432, 436, 437, 447

The ornamental design for goggles, as shown and described.

DESCRIPTION

[56] **References Cited**

U.S. PATENT DOCUMENTS

| | | | | |
|------------|---------|----------------|-------|---------|
| D. 364,181 | 11/1995 | Arnette | | D16/312 |
| D. 403,689 | 1/1999 | Mage | | D16/312 |
| D. 413,915 | 9/1999 | Newcomb et al. | | D16/312 |
| 5,138,723 | 8/1992 | Bollé | . | |
| 5,771,499 | 6/1998 | Monaco et al. | | 2/437 |
| 5,802,622 | 9/1998 | Baharad et al. | | 2/436 |

FIG. 1 is a perspective view of goggles showing my new design;
FIG. 2 is a front elevational view thereof;
FIG. 3 is a rear elevational view thereof with a portion of a headband cut away for clarity;
FIG. 4 is a left side elevational view thereof;
FIG. 5 is a right side elevational view thereof;
FIG. 6 is a top view thereof; and,
FIG. 7 is a bottom view thereof.

1 Claim, 3 Drawing Sheets

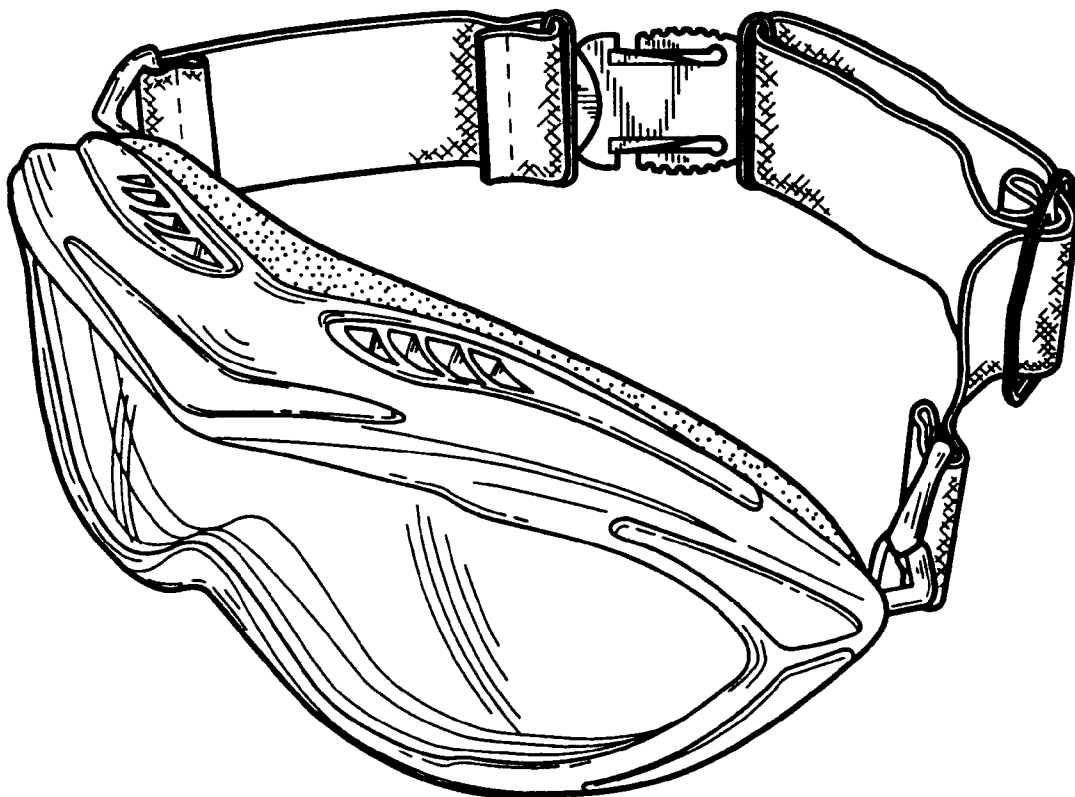

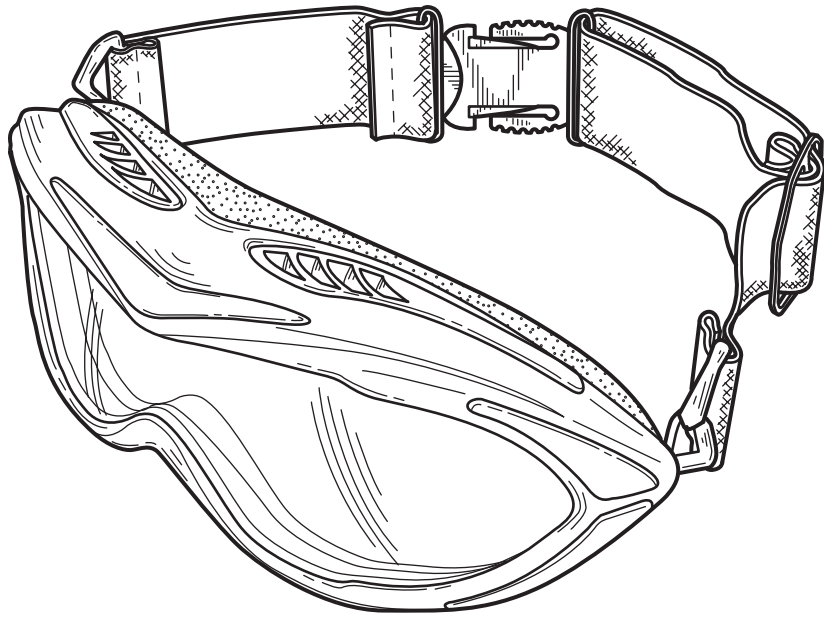

FIG.1

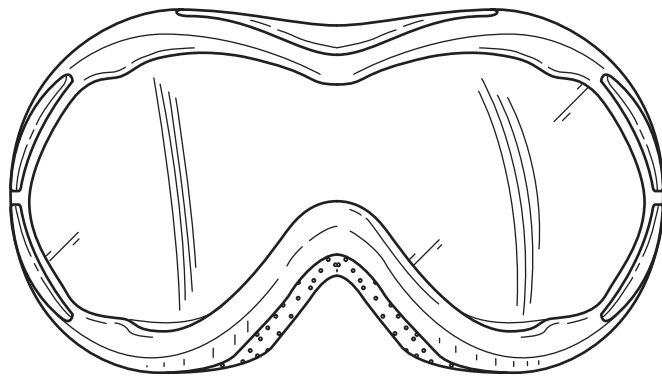

FIG.2

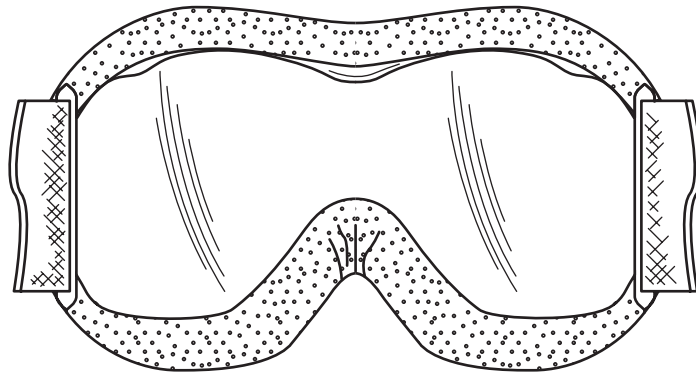

FIG. 3

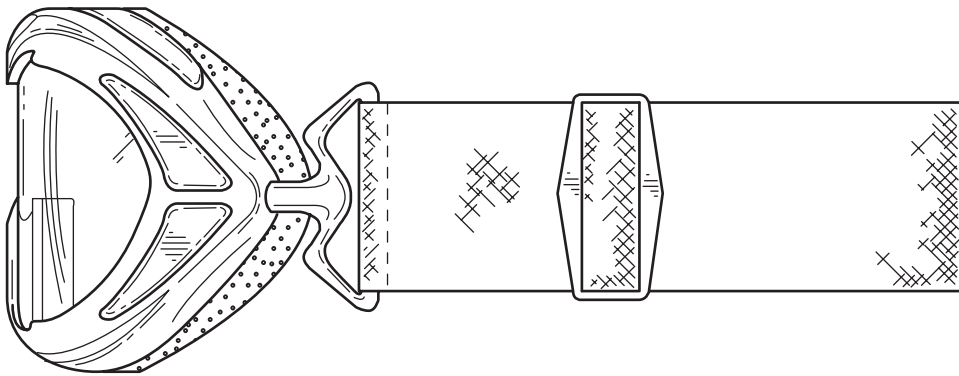

FIG. 4

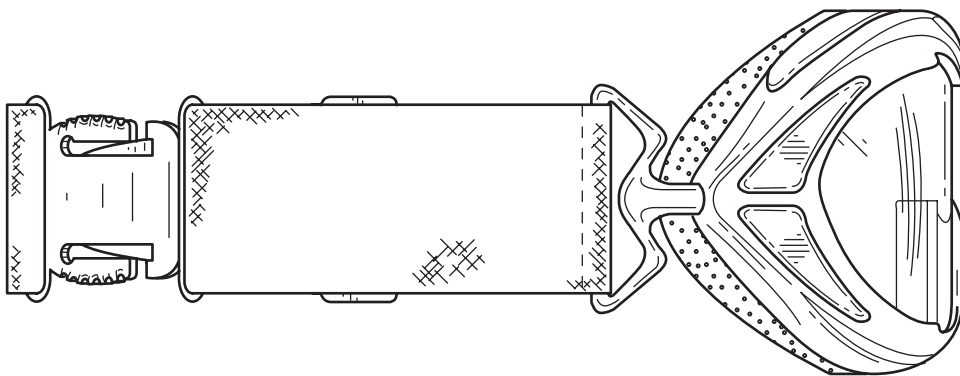

FIG. 5

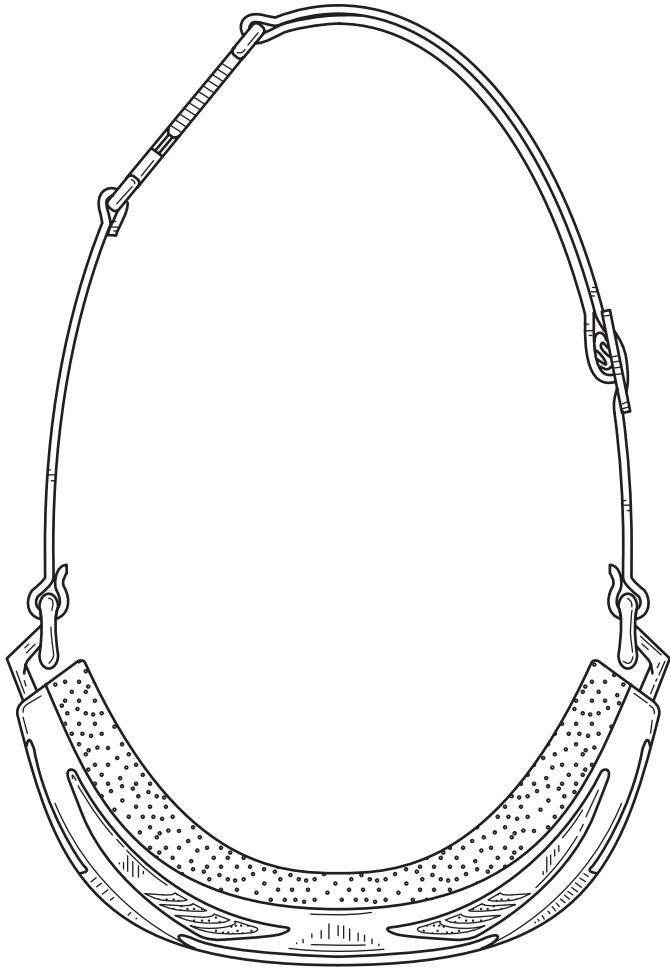

FIG. 6

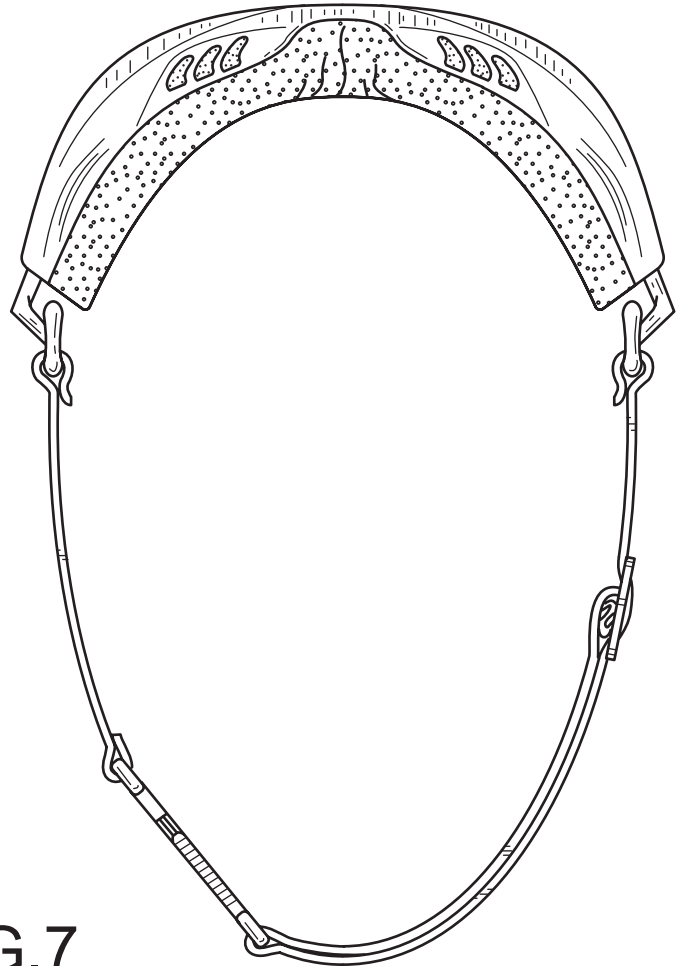

FIG. 7